



DRAGONFRAME

DMC+
Dragonframe Master Controller +
User Guide v1.1

DZED Systems LLC
407 Bryant Circle, Suite B
Ojai CA 93023
U.S.A.

support@dragonframe.com
+1.800.530.9124

Introduction

The DMC+ is an advanced motion control coordinator for use with Dragonframe software. It provides eight powered stepper motor drivers, plus eight step and direction signals at speeds up to 200kHz, a camera trigger, DMX512 lighting control, limit switch inputs, and a set of triggers for interfacing with an external device.

Safety Notice

Always use caution and common sense when operating motion control devices.

- Stand clear of your rig as much as possible.
- Begin with slower speed settings, and slowly work towards target speeds.
- Stand within reach of the E-STOP button on the case, or attach an external emergency stop switch that you can keep near you.

Technical Specifications

Maximum stepping pulse rate	200,000 steps/second (200kHz).	
Powered drivers	8 GeckoDrive 250x.	
Stepper driver current (A)	1A/2A/3A user switchtable.	
Stepper driver voltage (V)	30V.	
Outputs for stepper motors	Channels 1-8. Powered at 1A/2A/3A and 30V.	Pg. 5
Outputs for step and direction	8 differential RJ45 jacks. for channels 9-16.	Pg. 6
Camera trigger	One with separate metering and shutter options.	Pg. 7
DMX512	One output to control up to 99 lights.	Pg. 8
I/O triggers	For interfacing DMC+/Dragonframe with another external device. Includes a relay, logic level out, a switch input, and an emergency stop input.	Pgs. 9-10
Limit switch inputs	16 on DB25 (8 sets of low and high limits for motors 1-8).	Pg. 11

Installing Software Drivers

In order for Dragonframe to detect the DMC+ you may need to install FTDI drivers on your computer. Run Dragonframe, go to the Help menu and select “Install FTDI Drivers”.

Connecting to Dragonframe

Connect the provided USB cable between the DMC+ and a computer running Dragonframe. Power on the DMC+. In Dragonframe, go to the Scene : Connections settings and press “Add Connection” to create a connection. Choose “DMC+” as the device type, and find the DMC+ in the Location drop-down list.

On a Mac OS X system, you should see a device with “DMC+” in the name. On Windows, all ports show as “COM##”. However, if you go to the Windows Device Manager you can find the DMC16 and see its port number.

Refer to the Dragonframe User Guide and online tutorials for how to program moves and lighting sequences.

Updating Firmware

We may occasionally notify you of new firmware updates for the DMC+. To update the firmware:

1. Download the firmware file from our site. It should end with “.flash” or “.flash.txt”.
2. Turn off the DMC+.
3. Start Dragonframe.
4. On Windows and Linux, you will have to open a scene or create a new one to get access to the **Help** menu.
5. While holding down the E-STOP button on the front of the DMC+, power it on. You should see the LEDs moving up and down repeatedly.
6. Choose **Help : Update DMC Firmware**.
7. For the Firmware, press the **Choose** button and find the firmware file you downloaded.
8. For the Device, choose the DMC+ device that you have connected.
9. Press the **Start Upgrade** button.
10. You will see a progress bar, and the firmware upgrade should complete in under 30 seconds. If it fails, or takes longer than that, you can retry the procedure.

Stepper Motor Connector

There are eight 5-pin XLR powered stepper motor driver outputs, labeled 1 through 8. Each output is driven by a GeckoDrive G250x.

Use a 5-pin male XLR connector to wire your stepper motor to the output of the DMC+.

NOTE: These are high-current, powered outputs. Take caution when wiring up to them.

Wiring

1. A
2. A-
3. GND
4. B
5. B-

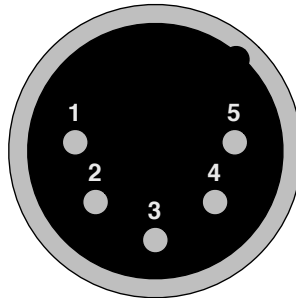

The current output to your motor runs at 1A, 2A or 3A. This is controlled by the switch on the front of the DMC+ for each channel.

The voltage for each channel is 30V. This is not configurable.

Choosing a Stepper Motor

You must choose a stepper motor that can run at 1A, 2A or 3A and 30V.

Here are some motors we recommend (many others will work as well):

Anaheim Automation 24Y204D-LW8

NEMA 24, high torque step motor, 56 mm length, 2.0A, 8 lead wires, dual shaft.
(This motor is used to drive the Volo's track and swing axes.)

Anaheim Automation Nema17

(This motor is used to drive the Volo's pan/tilt/roll head.)

RJ45 (Ethernet) Connector

There are eight RJ45 jacks on the rear of the DMC+. Each jack provides differential step and direction signals for one axis. The jacks are numbered 9 to 16 and correspond to motor/axis numbers.

Note: These outputs are compatible with the Arc Motion Control Octodrive.

Wiring

1. step +
2. step -
3. dir +
4. +5V
5. GND
6. dir -
7. +5V
8. GND

Differential Signals

The two pairs of signals, step+ / step- and dir+ / dir-, form differential pairs. Differential signals are relative only to each other and not to a common ground, which makes them less susceptible to noise. Some stepper motor drivers expect a differential signal.

If you want to use the differential signals with a motor driver that is not expecting differential signals, you can decode them on the receiving end using a “differential line receiver”. An example differential line receiver is Texas Instruments AM26C32CN. You can find this part at Digi-Key.

Single Ended Wiring

If you want to use the RJ45 jacks for step and direction, but do not have a differential receiver, you can just use the step+ and dir+ signals, along with the GND provided on pins 5 or 8. This non-differential wiring option is more susceptible to noise, especially over long cable runs.

CAMERA Connector

The camera connector can be used to trigger a DSLR camera for go-motion shooting. This is a 3-pin male XLR receptacle.

Wiring

1. Common
2. Shutter
3. Meter



To create your own connector cable, typically you would buy a wired remote shutter release for your camera and dismantle it. Most shutter releases have three wires: a common wire, a metering wire (connected to common when the button is pressed halfway) and a shutter release (connected to common when the button is pressed fully).

USB vs Hardware Shutter Release

Dragonframe can achieve fairly accurate shutter release timing over USB. However, USB can be prone to random timing delays, especially if your cable run is long.

If you need perfectly repeatable go-motion shots you will probably need to use the hardware shutter release through the camera connector.

Configuring Dragonframe to Use a Hardware Shutter Release

Normally Dragonframe controls the camera shutter release over USB. To allow the DMC+ to control the shutter electrically, you need to configure Dragonframe:

1. Open **Preferences : Capture** and check the **Allow external shutter control** checkbox. This will make a new camera setting called **SHUTTER**.
2. In the **Camera Settings** area of the **Cinematography** workspace, set the **SHUTTER** to **EXTERNAL** or **EXTERNAL BULB**.

DMX Connector

The DMX connector provides DMX512 signal over a 3-pin XLR cable. DMX512 (or DMX) is a standard protocol for controlling lighting. When paired with one or more DMX dimmer/switch packs, you can control up to 512 different light channels.

Note: Although 5-pin XLR is the official standard for DMX512, many consumer DMX512 products use a 3-pin variant.

Wiring

1. GND
2. DMX-
3. DMX+

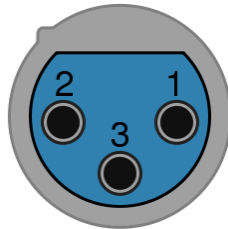

You may be tempted to use a standard microphone cable for DMX connections. However, we strongly recommend you use a cable designed specifically for DMX.

TRIGGERS Connector

The TRIGGERS connector provides a variety of inputs and outputs for connecting Dragonframe to external devices. The triggers are configured through Dragonframe’s Scene:Triggers settings.

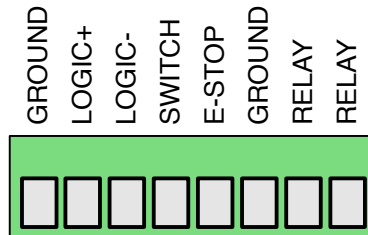

L+ / L- (Logic Level)

Logic level (+5V) outputs. L+ is normally low (GND) and goes high (+5V) when active. L- is the normally high (+5V) and goes low (GND) when active.

These two outputs are always tied to the same event—they cannot be programmed independently.

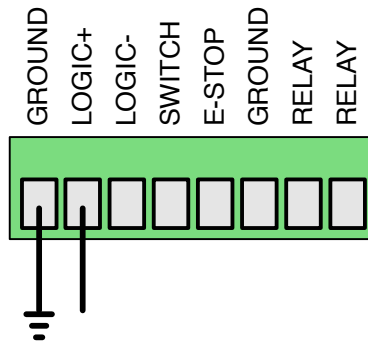

SW (Switch)

The switch input can be used to trigger Dragonframe. You should attach a normally open switch between SW and GND (either one).

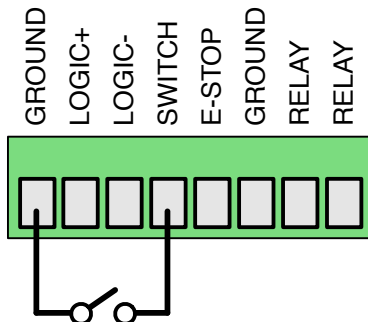

E-STOP (Emergency Stop)

The E-STOP input can provide a secondary emergency stop button. You should attach a NORMALLY CLOSED switch between E-STOP and GND. If you do not have your own e-stop switch to attach, you must use a wire to connect E-STOP and GND. If you do not, the DMC will think the e-stop is activated and will not move any motors.

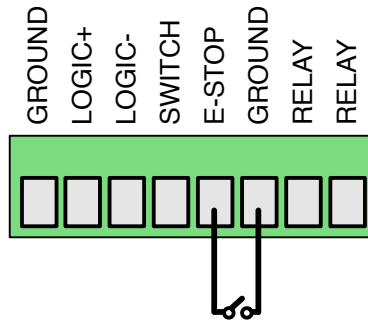

RLY (Relay)

The two RLY outputs provide a relay connection for triggering an external system. A relay closes the circuit between your two connected wires when it is activated.

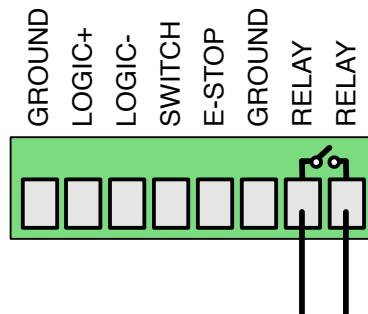

Trigger Connector

If you need a replacement trigger connector, look for Phoenix Contact part #1781043 at Mouser, Digi-Key, or any other electronic component site.

LIMIT SWITCHES Connector

The LIMIT SWITCHES connector provides high and low limit switch inputs for up to eight motor channels over a DB25 cable.

Each switch must be NORMALLY CLOSED.

You configure which limit switch set is used with an axis in the Arc axis configuration settings.

Wiring

1. Limit 1 Low
2. Limit 1 High
3. Limit 1 Common
4. Limit 2 Low
5. Limit 2 High
6. Limit 2 Common
7. Limit 3 Low
8. Limit 3 High
9. Limit 3 Common
10. Limit 4 Low
11. Limit 4 High
12. Limit 4 Common
13. Limit 5 Low
14. Limit 5 High
15. Limit 5 Common
16. Limit 6 Low
17. Limit 6 High
18. Limit 6 Common
19. Limit 7 Low
20. Limit 7 High
21. Limit 7 Common
22. Limit 8 Low
23. Limit 8 High
24. Limit 8 Common
25. Unused

Replaceable Parts

Make sure to unplug the AC cord before opening the case and replacing parts. All of these parts can be found on Mouser or Digi-Key.

Fuses

The fuses are small white ceramic fuses with metal ends, housed in an off-white plastic holder.

Most of the fuses are 375mA, although some one (LIMIT SWITCHES) is 62mA.

375mA: Littelfuse 0154.375DR (0.375A OMNI BLOK 154)

62mA: Littelfuse 0154.062DR (0.062A OMNI BLOK 154)

Trigger Connector

If you lose the green trigger connector (or somehow destroy it) you can order a new one.

Part: Phoenix Contact #1781043



RJ45 Step/Direction Output Drivers

If the step and direction signals on one or more channels stops working, the problem could be a blown differential line driver.

Part: TI AM26C31CN

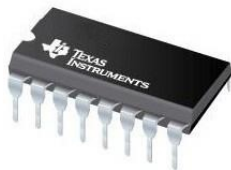

Motor Drivers

If you somehow blow a driver, you can replace it.

Geckodrive G250X with male headers.