



DRAGONFRAME

DMC-32
Dragonframe Master Controller
User Guide v1.0

DZED Systems LLC
407 Bryant Circle, Suite B
Ojai CA 93023
U.S.A.

support@dragonframe.com
+1.800.530.9124

Introduction

The DMC-32 is an advanced motion control coordinator for use with Dragonframe software. It provides 32 channels of fully synchronized step and direction signals at speeds up to 200kHz, a camera trigger, DMX512 lighting control, limit switch inputs, and a set of triggers for interfacing with an external device.

Safety Notice

Always use caution and common sense when operating motion control devices.

- Stand clear of your rig as much as possible.
- Begin with slower speed settings, and slowly work towards target speeds.
- Stand within reach of the E-STOP button on the case, or attach an external emergency stop switch that you can keep near you.

Technical Specifications

Input Voltage	115 VAC to 230 VAC.	
Maximum stepping pulse rate	200,000 steps/second (200kHz).	
Camera trigger	One with separate metering and shutter options.	Pg. 5
Timecode Input	Receive LTC over the BNC connector, for perfectly synced repeat live passes.	Pg. 6
DMX512	One output to control up to 512 lights.	Pg. 7
Outputs for step and direction	16 differential step/direction RJ45 jacks for channels 1-16.	Pgs. 8-9
Legacy motion control compatibility	16 single-ended step/direction pairs over DB37, for channels 17-32.	Pg. 9
I/O triggers	For interfacing DMC-32/Dragonframe with another external device. Includes a relay, logic level out, a switch input, and an emergency stop input.	Pgs. 10-11
Limit switch inputs	16 on DB25 (8 sets of low and high limits for motors 1-8).	Pg. 12

Installing Software Drivers

macOS 10.9+ does not need software drivers for the DMC+.
Windows 10 does not need software drivers for the DMC+.
Older versions of Windows need the FTDI drivers.

Connecting to Dragonframe

Connect the provided USB cable between the DMC-32 and a computer running Dragonframe. Power on the DMC-32. In Dragonframe, go to the Scene : Connections settings and press “Add Connection” to create a connection. Choose “DMC-32” as the device type, and find the DMC-32 in the Location drop-down list.

On a Mac OS X system, you should see a device with “DMC32” in the name. On Windows, all ports show as “COM##”. However, if you go to the Windows Device Manager you can find the DMC32 and see its port number.

Refer to the Dragonframe User Guide and online tutorials for how to program moves and lighting sequences.

Updating Firmware

We may occasionally notify you of new firmware updates for the DMC-32.
To update the firmware:

1. Download the firmware file from our site. It should end with “.flash” or “.flash.txt”.
2. Turn off the DMC-32.
3. Start Dragonframe.
4. On Windows and Linux, you will have to open a scene or create a new one to get access to the **Help** menu.
5. While holding down the E-STOP button on the front of the DMC-32, power it on. The screen will show a message that it is waiting for a firmware update.
6. Choose **Help : Update DMC** Firmware.
7. For the Firmware, press the **Choose** button and find the firmware file you downloaded.
8. For the Device, choose the DMC-32 device that you have connected.
9. Press the **Start Upgrade** button.
10. You will see a progress bar, and the firmware upgrade should complete in under 30 seconds. If it fails, or takes longer than that, you can retry the procedure.

CAMERA Connector

The camera connector can be used to trigger a DSLR camera for go-motion shooting. This is a 3-pin stereo miniplug (TRS) receptacle.

Wiring

Sleeve: Common
Tip: Shutter
Ring: Meter

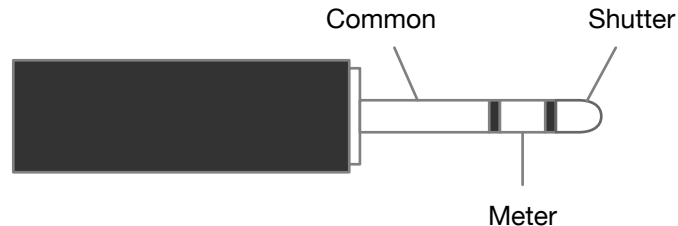

To create your own connector cable, typically you would buy a wired remote shutter release for your camera and dismantle it. Most shutter releases have three wires: a common wire, a metering wire (connected to common when the button is pressed halfway) and a shutter release (connected to common when the button is pressed fully).

USB vs Hardware Shutter Release

Dragonframe can achieve fairly accurate shutter release timing over USB. However, USB can be prone to random timing delays, especially if your cable run is long.

If you need perfectly repeatable go-motion shots you will probably need to use the hardware shutter release through the camera connector.

Configuring Dragonframe to Use a Hardware Shutter Release

Normally Dragonframe controls the camera shutter release over USB. To allow the DMC-32 to control the shutter electrically, you need to configure Dragonframe:

1. Open **Preferences : Capture** and check the **Allow external shutter control** checkbox. This will make a new camera setting called **SHUTTER**.
2. In the **Camera Settings** area of the **Cinematography** workspace, set the **SHUTTER** to **EXTERNAL** or **EXTERNAL BULB**.

LTC Connector

The DMC-32 has a BNC connector for receiving LTC (linear timecode).

This can be used to sync repeated live action passes.

The timecode signal must be provided, and stay present, in order for the DMC-32 to sync to it.

ARRI Cameras

You should be able to take the LTC output of an ARRI camera and feed it into the DMC-32.

Since ARRI cameras tie sensor timing to timecode generation, this should achieve synchronization.

RED Cameras

In order to sync with RED cameras, you must use a timecode generator that provides both timecode and genlock output.

Configure the RED to receive genlock. Note that RED requires a specific cable to receive genlock signals. Also, the RED cable has a female end, so you will need a BNC female to female adapter.

We achieved synchronization using the Atomos Ultrasync One:

1. Configure the Ultrasync to send genlock over the SYNC cable to the RED camera.
2. Connect the Ultrasync LTC output to the LTC input on the DMC-32.

DMX Connector

The DMX connector provides DMX512 signal over a 3-pin XLR cable. DMX512 (or DMX) is a standard protocol for controlling lighting. When paired with one or more DMX dimmer/switch packs, you can control up to 512 different light channels.

Note: Although 5-pin XLR is the official standard for DMX512, many consumer DMX512 products use a 3-pin variant.

Wiring

1. GND
2. DMX-
3. DMX+

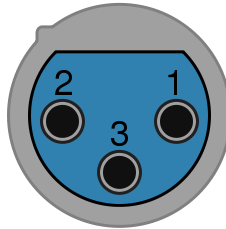

You may be tempted to use a standard microphone cable for DMX connections. However, we strongly recommend you use a cable designed specifically for DMX.

RJ45 (Ethernet) Connector

There are sixteen RJ45 jacks on the rear of the DMC-32. Each jack provides differential step and direction signals for one axis. The jacks are numbered 01 to 16 and correspond to motor/axis numbers.

Note: These outputs are compatible with the Arc Motion Control Octodrive.

Wiring

1. step +
2. step -
3. dir +
4. +5V
5. GND
6. dir -
7. +5V
8. GND

Differential Signals

The two pairs of signals, step+ / step- and dir+ / dir-, form differential pairs. Differential signals are relative only to each other and not to a common ground, which makes them less susceptible to noise. Some stepper motor drivers expect a differential signal.

If you want to use the differential signals with a motor driver that is not expecting differential signals, you can decode them on the receiving end using a “differential line receiver”. An example differential line receiver is Texas Instruments AM26C32CN. You can find this part at Digi-Key.

Single Ended Wiring

If you want to use the RJ45 jacks for step and direction, but do not have a differential receiver, you can just use the step+ and dir+ signals, along with the GND provided on pins 5 or 8. This non-differential wiring option is more susceptible to noise, especially over long cable runs.

STEP/DIR Connector

The STEP/DIR connector provides 16 channels of step and direction signals over a DB37 cable. These are single-ended (non-differential) signals.

Wiring

1. GND	20. +5V
2. step 17	21. dir 17
3. step 18	22. dir 18
4. step 19	23. dir 19
5. step 20	24. dir 20
6. step 21	25. dir 21
7. step 22	26. dir 22
8. step 23	27. dir 23
9. step 24	28. dir 24
10. step 25	29. dir 25
11. step 26	30. dir 26
12. step 27	31. dir 27
13. step 28	32. dir 28
14. step 29	33. dir 29
15. step 30	34. dir 30
16. step 31	35. dir 31
17. step 32	36. dir 32
18. GND	37. +5V
19. GND	

TRIGGERS Connector

The TRIGGERS connector provides a variety of inputs and outputs for connecting Dragonframe to external devices. The triggers are configured through Dragonframe's Scene:Triggers settings.

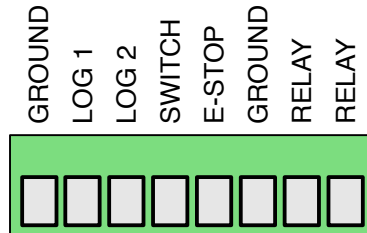

LOG 1 & LOG 2 (Logic Level)

Logic level (+5V) outputs. Both are normally low (GND) and go high (+5V) when active.

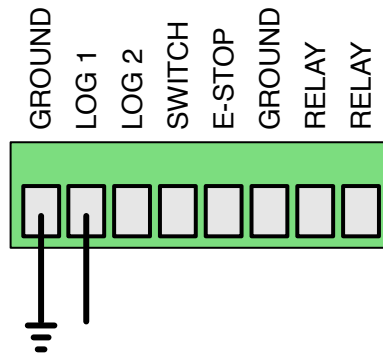

SW (Switch)

The switch input can be used to trigger Dragonframe. You should attach a normally open switch between SW and GND (either one).

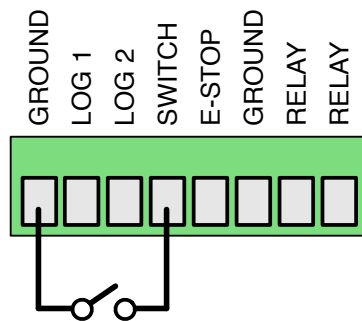

E-STOP (Emergency Stop)

The E-STOP input can provide a secondary emergency stop button. You should attach a NORMALLY CLOSED switch between E-STOP and GND. If you do not have your own e-stop switch to attach, you must use a wire to connect E-STOP and GND. If you do not, the DMC will think the e-stop is activated and will not move any motors.

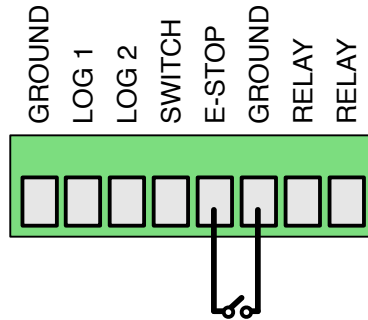

RLY (Relay)

The two RLY outputs provide a relay connection for triggering an external system. A relay closes the circuit between your two connected wires when it is activated.

Contact Ratings:

Power, Switching: 10W max

Voltage, Switching: 200 Vdc max

Current, Switching: 0.5 A max

Note: You can find the full specs by looking up the product, "Littelfuse Inc. HE721A0500".

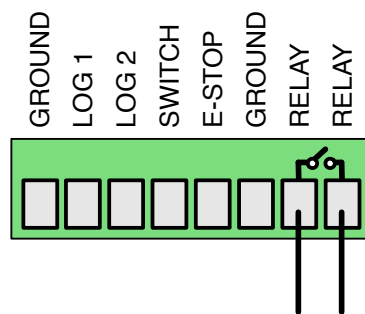

Trigger Connector

If you need a replacement trigger connector, look for Phoenix Contact part #1781043 at Mouser, Digi-Key, or any other electronic component site.

LIMIT SWITCHES Connector

The LIMIT SWITCHES connector provides high and low limit switch inputs for up to eight motor channels over a DB25 cable.

Each switch must be NORMALLY CLOSED.

You configure which limit switch set is used with an axis in the Arc axis configuration settings.

Wiring

1. Limit 1 Low
2. Limit 1 High
3. Limit 1 Common
4. Limit 2 Low
5. Limit 2 High
6. Limit 2 Common
7. Limit 3 Low
8. Limit 3 High
9. Limit 3 Common
10. Limit 4 Low
11. Limit 4 High
12. Limit 4 Common
13. Limit 5 Low
14. Limit 5 High
15. Limit 5 Common
16. Limit 6 Low
17. Limit 6 High
18. Limit 6 Common
19. Limit 7 Low
20. Limit 7 High
21. Limit 7 Common
22. Limit 8 Low
23. Limit 8 High
24. Limit 8 Common
25. Unused

FUSE MAP

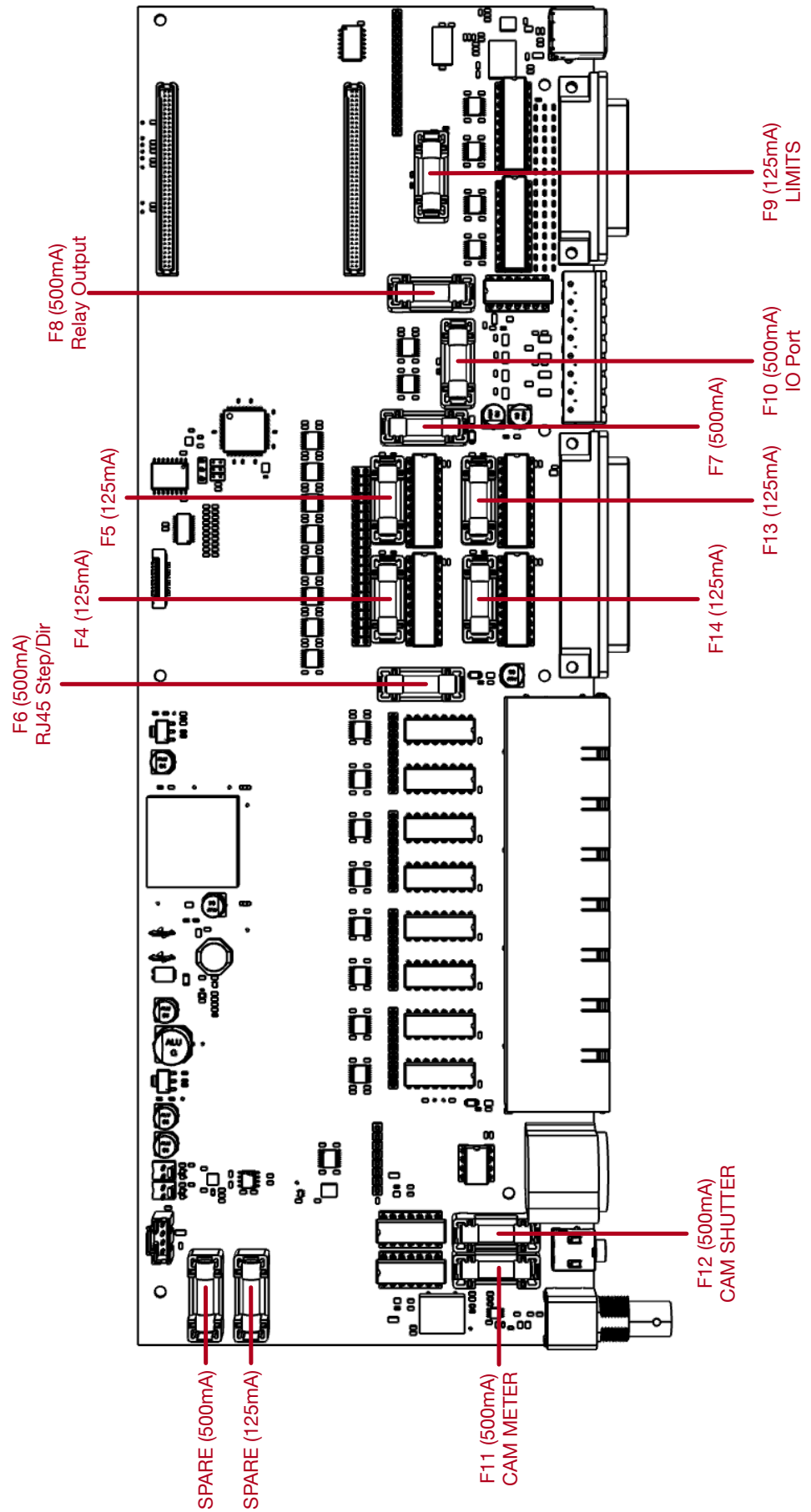

Replaceable Parts

Make sure to unplug the AC cord before opening the case and replacing parts. All of these parts can be found on Mouser or Digi-Key. The next page shows a layout of these parts.

Fuses

The design uses 5x20mm glass cartridge fuses in two different values:
125mA: Littelfuse 0235.125MXP
500mA: Littelfuse 0617.500MXP

There are two spare fuses, located on the upper-left side of the main PCB.

Trigger Connector

If you lose the green trigger connector (or somehow destroy it) you can order a new one.



Part: Phoenix Contact #1781043

Relay Switch

The trigger relay, the camera shutter, and camera meter all use the same relay switch.

Part: Littelfuse Inc. HE721A0500

RJ45 Step/Direction Output Drivers

If the step and direction signals on one or more channels stops working, the problem could be a blown differential line driver.

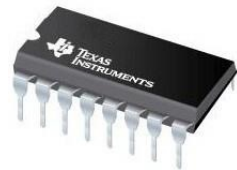

Part: TI AM26C31CN

DB37 Step/Direction Output Driver

If the step or direction signals from the DB37 stop working, you may need to replace the buffered driver. There are four driver chips, each one carrying eight signals.

Part: TI CD74ACT541E

Limit Switch Driver

If half of the limit switches stop working, you may need to replace the socketed chips for them.

Part: TI SN74LVC245AN

REPLACEMENT PART MAP

RELAY, METER, SHUTTER - Littelfuse Inc. HE721A0500
 RJ45 STEP/DIR - TI AM26C31CN
 DB37 STEP/DIR - TI SN74ALS541N
 DB25 LIMITS - TI SN64LVC245AN

